



Say-Core, Inc.



P.C.I. Certified Plant

Manufacturers of Precast Concrete Hollow-Core Plank

132 BLOCK ROAD
PORTAGE, PA 15946

www.saycore.com
draftingsaycore@hotmail.com

(814) 736-8018 OFFICE
(814) 736-8485 FAX

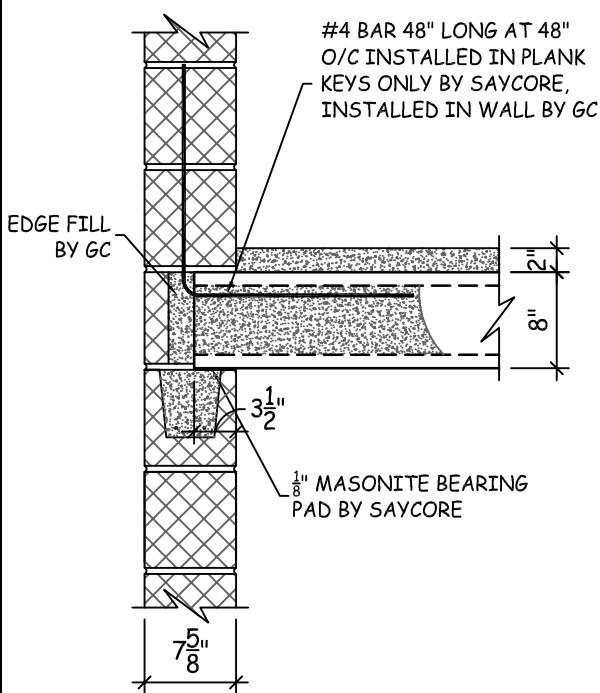

TYP. SECTION

SCALE: 3/4"=1'

5

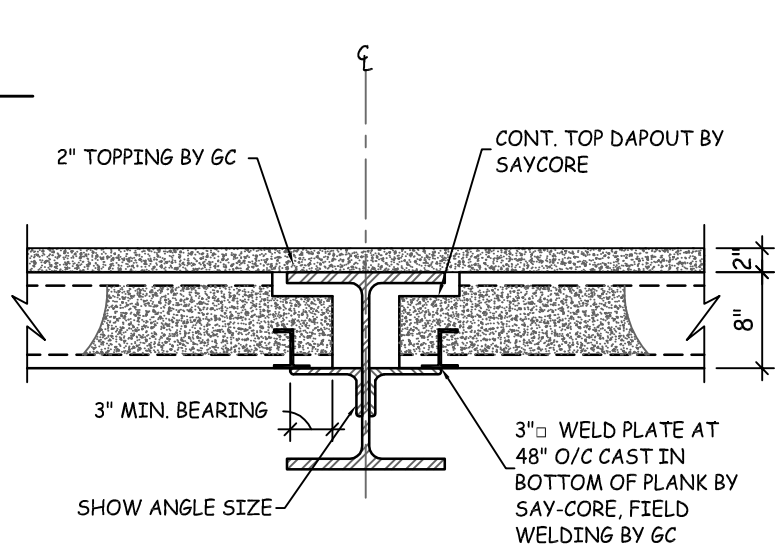

TYP. SECTION

SCALE: 3/4"=1'

6

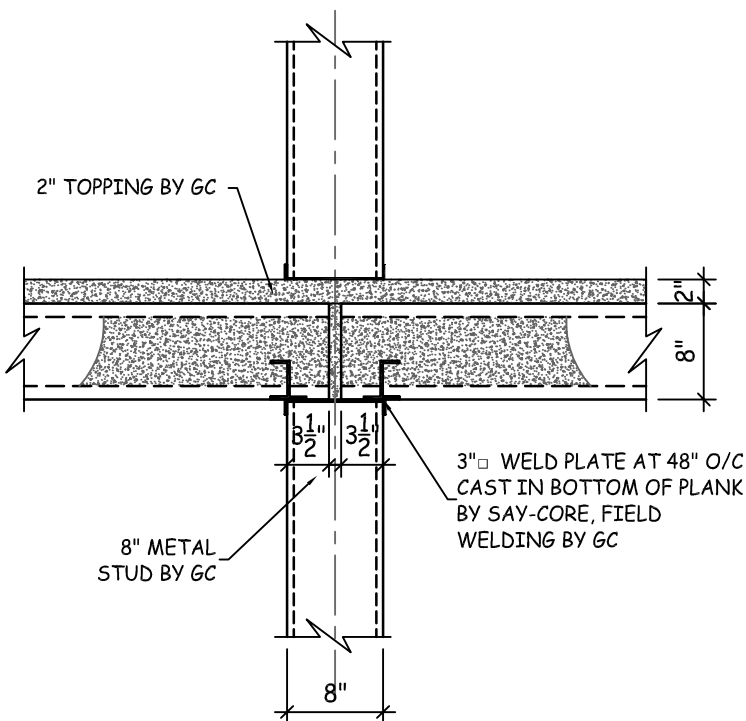

TYP. SECTION

SCALE: 3/4"=1'

7

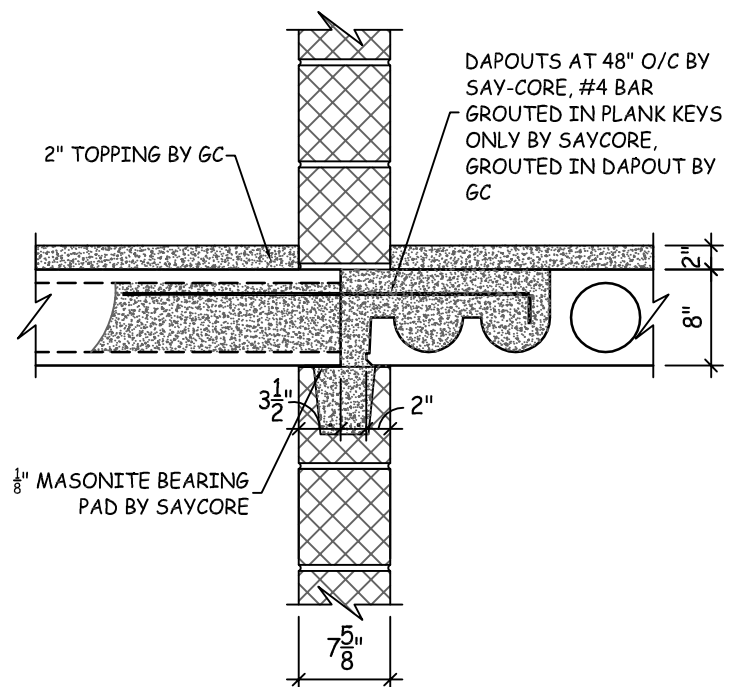

TYP. SECTION

SCALE: 3/4"=1'

8